





# ASSEMBLY INSTRUCTIONS

- (A)  3.5x60 10+1PCS
- (B)  3.5x40 18+1PCS
- (C)  3.5x35 14+1PCS
- (D)  3.5x25 4+1PCS
- (E)  3.0x16 8+1PCS
- (F)  (L=270mm) 1PC



3

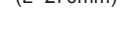
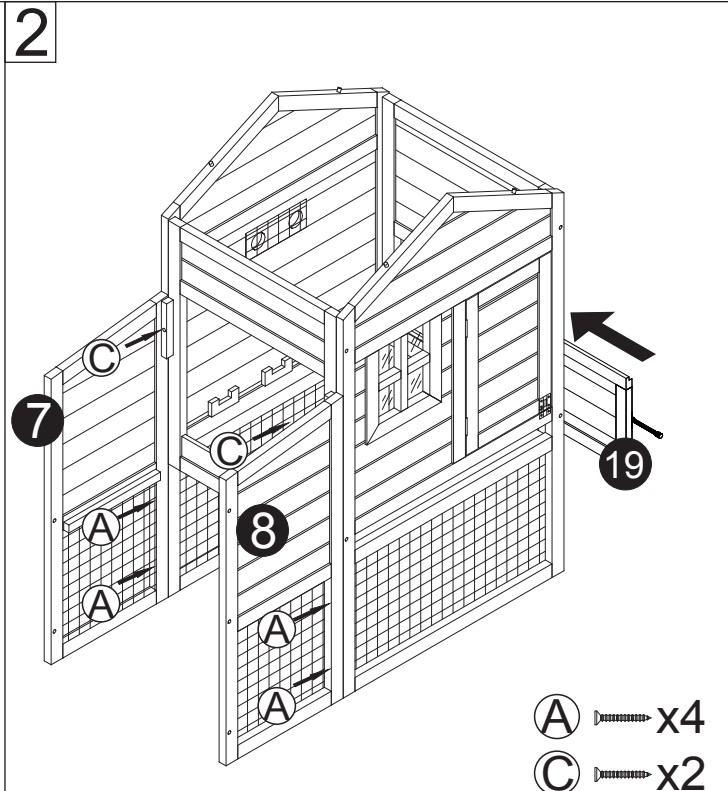
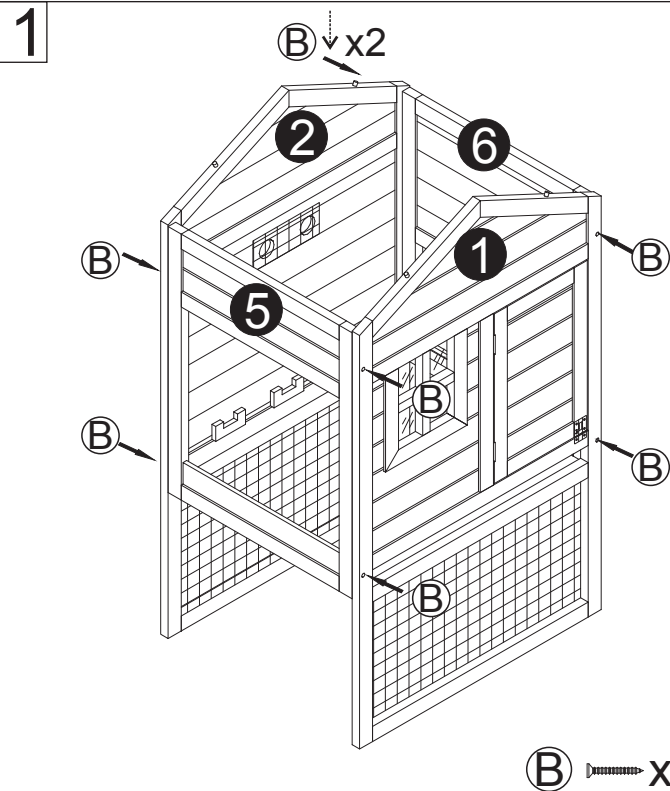
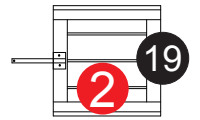
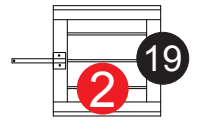
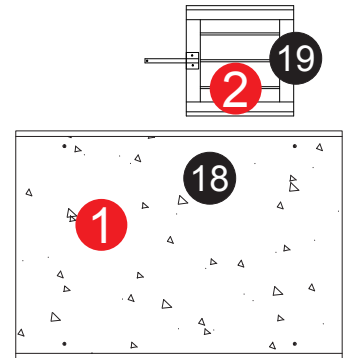
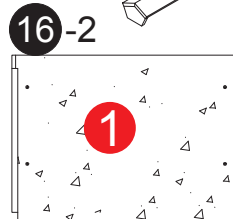
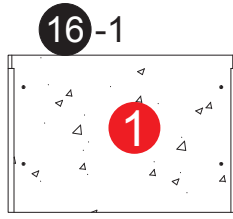
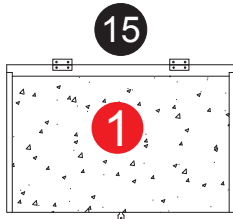
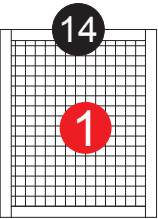
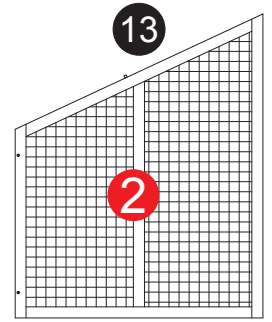
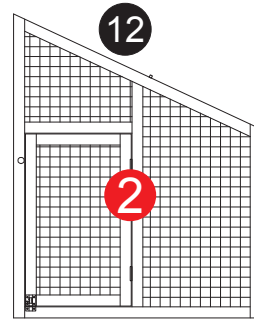
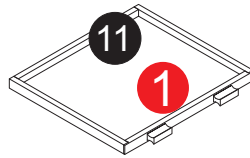
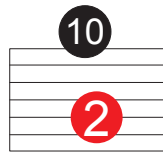
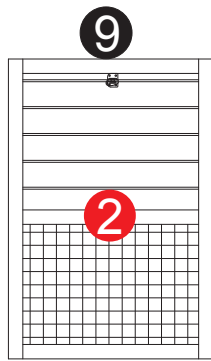
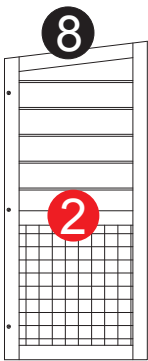
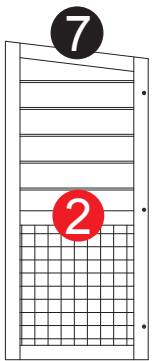
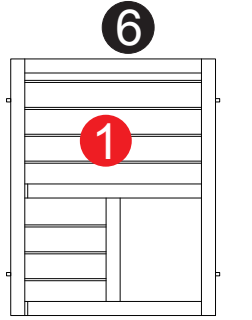
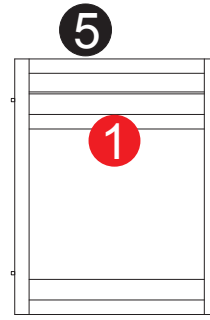
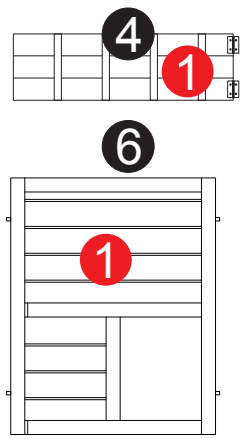
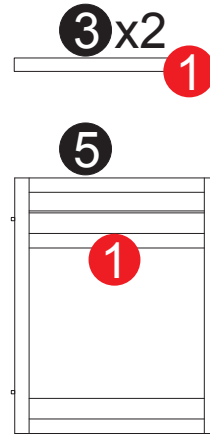
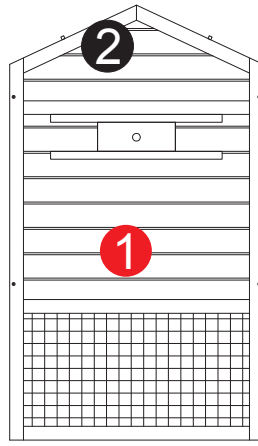
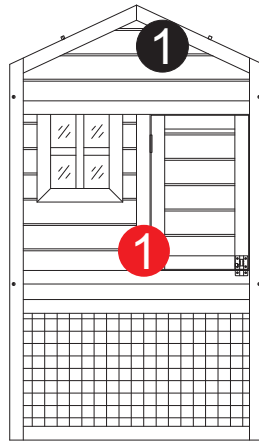
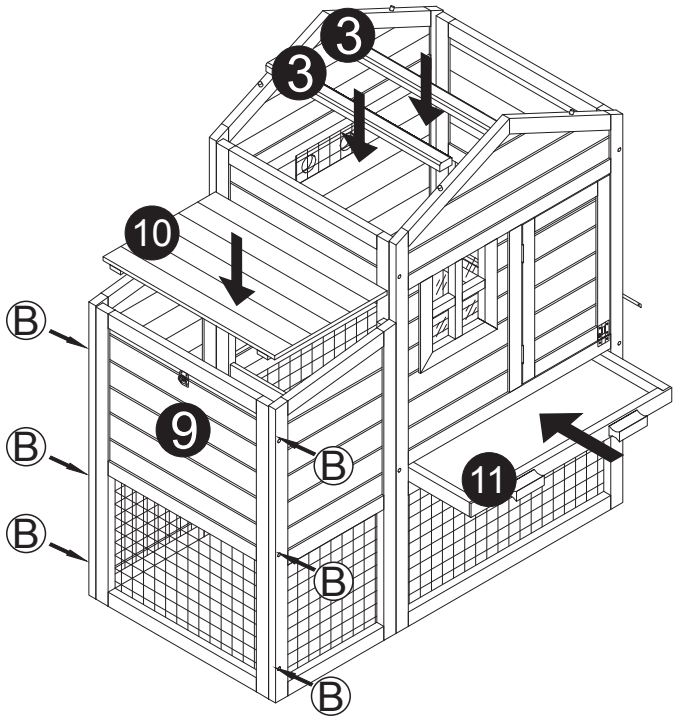

(B) → x6

4

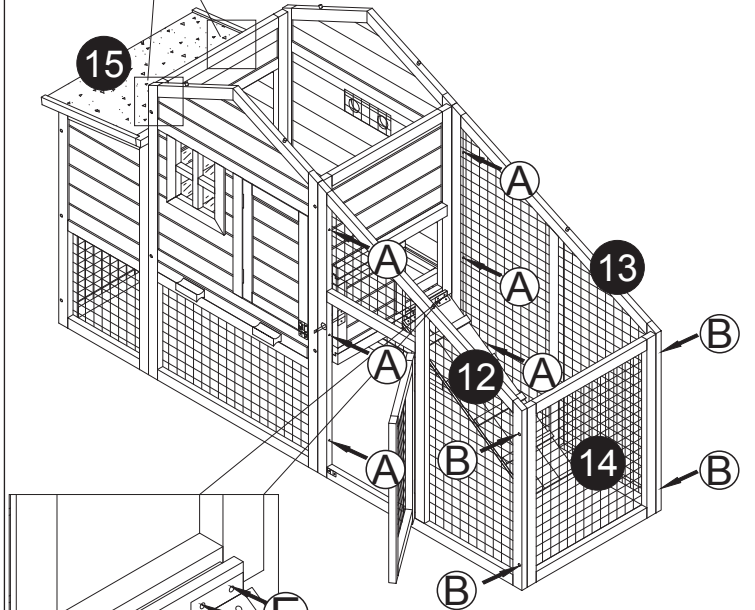
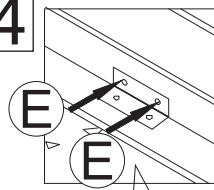

(A) → x6

(B) → x4

(E) → x8

attention the position

5

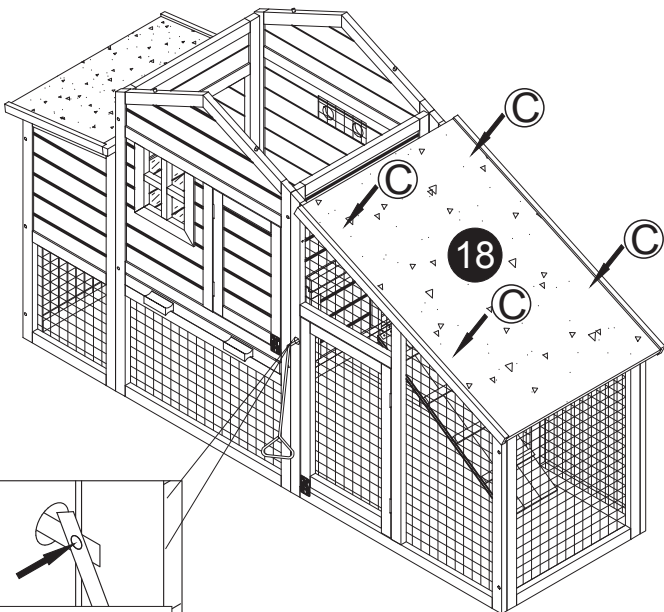

(C) → x4

(F) → x1

6

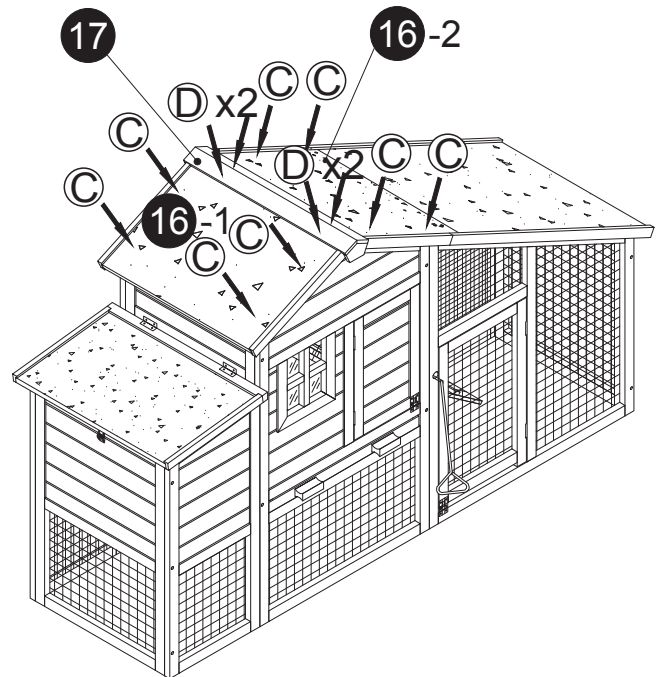

(C) → x8

(D) → x4