



Jeep[®] Wrangler

Model: DK-JWR555
 Age Range: 37-95 Month
 Maximum Weight: 35 KGS
 Execution Standard:

EN71&EN62115



*The battery on the vehicle is not replaceable.

 Pictures are for reference only, please adhere to the original products as standard



Jeep, the Jeep grille and related logos, vehicle model names and trade dress are trademarks of FCA US LLC and used under license by Pinghu Dake Baby Carrier Co.,Ltd. ©2019 FCA US LLC.

Warning: This is a Child's Toy and NOT intended for Off-Road Use.

All spare parts When open the carton



With MP4 configuration, there is no MP3 cable

Assembling Procedure:
 Must be assembled by Adults

1. Install front bumper and motors

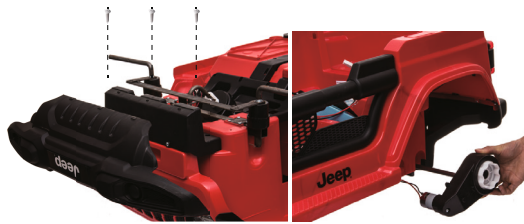

Please find motors first, and disconnect them; Insert motors to the axle, and insert lines into the hole of car body. Connect power lines again. (Please refer to the photo)

2. Install wheels



Please install motor, wheel, bushing, gasket, nut, wheel cover following the sequence. (No need bushing when install EVA wheels)

3. Install steering wheel



Connect power line first, and then assemble the steering wheel by pressing it down directly.

4. Install windshield and hood



5. Install rear view mirrors



Please insert the rear view mirrors referring to the photo, and pay attention to left and right.

6. Install rear searching lights



(Please refer to the photo)

7. Install seat built in fitment



(Please refer to the photo)

8. Power Connection

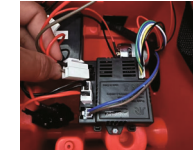

Connect power referring to the photo.

(Please refer to the photo)

9. Install seat



(Please refer to the photo)

10. Seat and Spare Wheel



(Please refer to the photo)

Explosive View

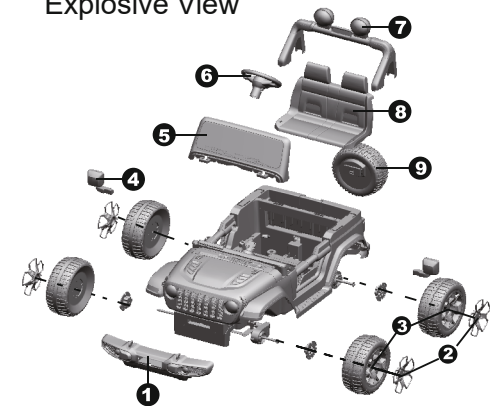

1. Front bumper	4. Rear view mirror	7. Searching light
2. Wheel cover	5. Wind Shield	8. Seat
3. Wheel	6. Steering wheel	9. Spare Wheel

Specifications

Item	Specifications
Battery	12V7AH*1/12V10AH*1
Motor	35W
Available Ages	Children from 37-95 month
Maximum Weight	35KGS
Size	126*70*80CM
Speed	3-5km/h
Remote Control Batteries	2PCS of AAA Batteries
Charger	Input:220V/110V Output:DC12v1000MA

CHARGING PRECAUTIONS

Battery polarity cannot be reversed, please ensure the red wire is connected to the red battery terminal and the black wire is connected to the black battery terminal

- Press the power switch to OFF position to turn the power off.
- Open the seat, connect the battery plug, red to red.
- Never drain battery completely or to a crawling speed, recharge the battery when a decrease in speed and power is noticed. Warranty will be voided if misuse has occurred.
- Battery charging must be done by adults only. Never allow children to charge the battery. A child could be injured by the electricity involved in charging the battery.
- Please don't connect the wires to a short circuit. The charger and the battery are not a toy. Do not allow children to play with the charger and the battery. Only operate the battery and charger specified according to the manual instructions.
- Please do not open the battery and the charger.
- To maintain safety of vehicle, always secure the battery with the bracket.
- The battery must be handled and operated by adults only: the battery is heavy and contains sulfuric acid (electrolyte). Dropping the battery could result in serious injury
- Before charging the battery check for wear or damage to the battery, charger, the connectors and other parts. If any damage found, the charger should be repaired or replaced immediately. Do not use a damaged charger.
- It is normal for the adaptor to feel warm during charging, but if the charger feels too hot, stop charging immediately and check the battery and adaptor. When charging please turn off the power switch. Please charge the battery for 8-10 hours after first use. Subsequent charges should be 6-8 hours but not exceeding 10 hours. If do not use the car for a long time, please charge at least once a month to keep the battery cells active.

1. Plug the charger into the charging socket.
2. Plug the other end of the charger into your wall socket. Batteries are perishable items that are subject to under and over charging. Please observe the charging time.

TROUBLESHOOTING

Problem: The car will not move

Answer 1: The battery is low, please charge for 6-8 hours but not exceeding 10 hours.
Charge at least once a month to keep the battery cells active.
Answer 2: The battery is low. Please charge the battery for 6-8 hours but not exceeding 10 hours.
Charge at least once a month to keep battery cells active.

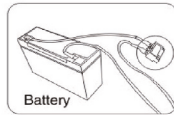

To avoid short fuse or power cut off:

1. Do not overload the product. Max load is 35Kg.
2. Do not drag any item behind this product.
3. Do not allow water or any liquid into electric parts.
4. Do not change wire system without a professional.

TROUBLESHOOTING

Problem: The car only runs for a short time

Answer 1: The battery is low, please charge for 6-8 hours but not exceeding 10 hours.
Charge at least once a month to keep the battery cells active.
Answer 2: The battery may need to be replaced depending on its charging history and age.

Problem: The sound does not work.

Please ensure the volume is turned up and the MP3 line is not connected. Sounds from steering wheel will not work when MP3 is plugged in.

Problem: Charger overheating

It is normal for battery and charger to be slightly warm during charging. If the charger feel excessively hot, please check for a current overload or battery short circuit.

SAFETY PRECAUTIONS

01. While driving, adult supervision is required all the time
02. Always wear a helmet when driving
03. Please don't drive near road or on the footpath.
04. It is not recommended to drive the vehicle on wet surface or on slope greater than 15-degree.
05. It is recommended to drive this vehicle on smooth surface only.
06. Please don't drive this vehicle outdoors when it is raining.
07. Make sure that the vehicle stop completely before changing direction from forward to reverse
08. Please don't allow children to operate the charger or play with the battery
09. Clean the vehicle with a dry cloth only.
10. Please follow the correct weight and age limits allowed to drive this vehicle.
11. It is prohibited to change the circuit or add other electric parts.
12. Adults must teach their children about safe driving procedures.
13. Please turn the power off when not in use.
14. Check the seat to ensure it has been fitted and secured with a bolt before driving.
15. Inspect all wires and connection of the vehicle periodically.
16. Charging the battery should only be done by adults.
17. Charging plug is located underneath the seat.
18. In order to avoid accidents, please ensure the vehicle is safe before driving.
19. Please don't let children touch the wheels or be near them when the car is moving.
20. Please mind fingers when opening and closing doors.

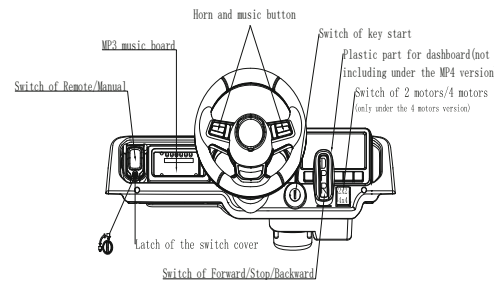

Description for the switch of Manual / Remote:
Under the Manual: the car only can drive by the child;
Under the Remote: the car only can drive by the remote control:

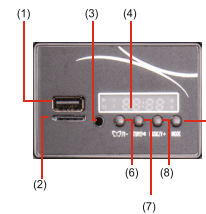

1. socket
2. Storage card socket
3. Audio input
4. Display
5. MODE choose (Radio/wireless connection/Storage card connection)
6. Education (Pressing for a longer time and it will lower the volume)
7. Story/Play/ Pause under the wireless connection/Storage card functions
8. Music (Pressing for a longer time and it will higher the volume)

1. Press the music button on the steering wheel for horn or music.
2. Plug in your MP3 device to play your own music through the car. Please note the steering wheel sounds will not work when the MP3 device is connected.

Please note the steering wheel sounds will not work when the MP3 lead is connected.

2.4G Remote Control Instructions

- Step 1: The Remote Controller is loaded with two AAA batteries.
Step 2: Turn off the power switch on the vehicle.
Step 3: Hold down "▲" & "▼" keys for 3 seconds start match code. The first LED flicker, Now turn on the vehicle power switch. The red indicator lights stop flashing, and the code is successful. "▲" Forward, "▼" Back, "◀" Left, "▶" Right, Press "P" key hold the brake, All LED flicker

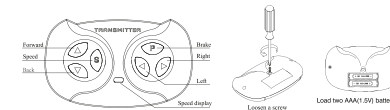

WARNING!

- Not for children under 3 years. Small parts. Choking hazard
- Load two AAA (1.5V) batteries according to the diagram.
 - Non-rechargeable batteries are not to be recharged.
 - Different types of batteries or new and used batteries are not to be mixed.
 - Batteries are to be inserted with the correct polarity.
 - Exhausted batteries are to be removed from the toy.
 - The supply terminals are not to be short-circuited.
 - The packaging must be retained since it contains important information.
- Load two AAA(1.5V) batteries

WARNING!

- For safety reasons,
- *please use this vehicle under adult guidance and supervision.
 - *do not use this product on main roads, slopes, highways or other dangerous places.
 - *children must wear shoes and protective gears when operating the vehicle.
 - *children should be seated with the seat belt fasten when driving.
 - *only load a maximum of 35Kg on the vehicle.
 - *only children aged 37 - 95 months should be allowed on this vehicle.
 - *use this toy strictly according to safety manual.
 - *please check the tires, breaks, steering wheels, seats and seat belts before operating vehicle.
 - *this toy vehicle should be used with caution and requires skill to avoid fall or collision with third parties.

*The remote control is not a toy. It is for the adult only, and should not be used by a child. A close adult supervision is always required. Reception range may change significantly with weather, battery, and other environmental conditions.

*The batteries in remote control are replaceable. When replacing a replaceable battery, first open the lid and take out the old battery. Put in the new battery, pay attention to the positive and negative poles, cover the lid.

*The battery on the vehicle is not replaceable.

*To reduce the risk of injury, adult supervision is required.

*Never use in roadways, near motor vehicles, on or near steep inclines or steps, swimming pools or other bodies of water; always wear shoes, and never allow more than 1 rider.

Pictures are for reference only, please adhere to the original products as standard